

DO NOT SCALE

1/04/2015

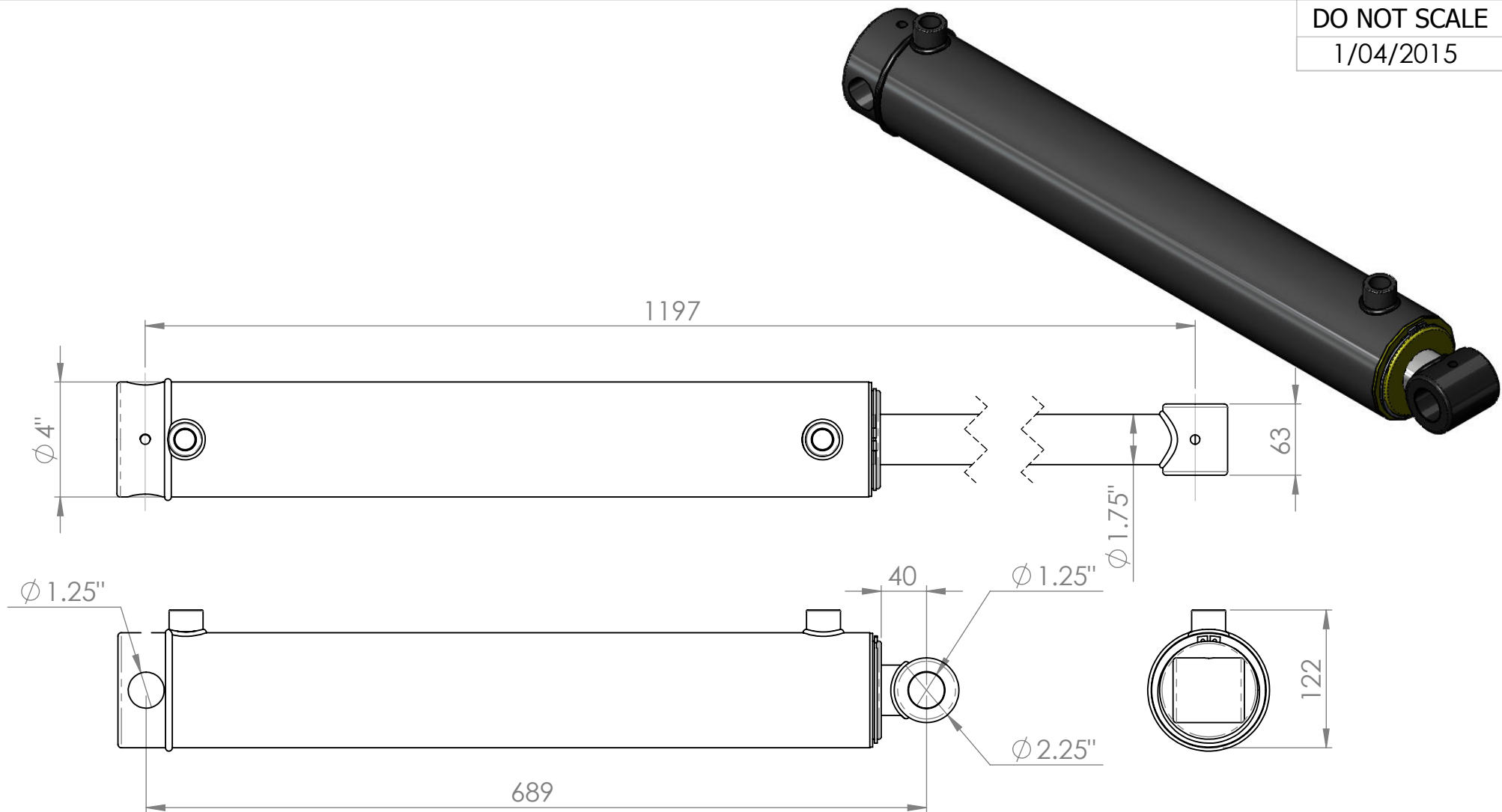

The information contained in this drawing is proprietary to MOTUS and shall not be reproduced or disclosed in whole or in part or used for any design or manufacture except when such user possesses direct written authorisation from MOTUS

Ram Phone: 0800 66 88 74
 Phone: +64 6 879 8590
 sales@motushydraulics.co.nz
 www.motushydraulics.co.nz

DESCRIPTION	SB-C350175x508(20")	RATED OPERATING PRESSURE:	
SEAL KIT No:	SK350175	FORCE EXTENSION	7210 Kg @2250 psi
FORCE EXTENSION	9620 kg @2250 psi	FORCE RETRACT	7210 Kg @2250 psi
STROKE	508mm	PORTS	1/2" F/M BSPP
CLOSED CENTRES	689mm	BASE MOUNT	SB-
OPEN CENTRES	1197mm	SHAFT MOUNT	C-31